

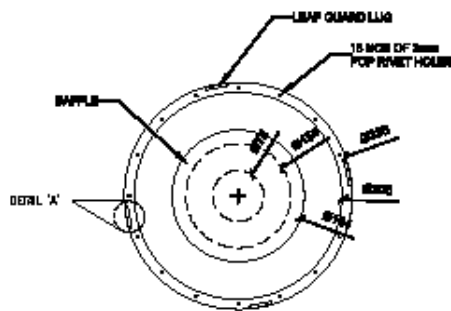

GUTTER INLET LEAFGUARD PLAN VIEW

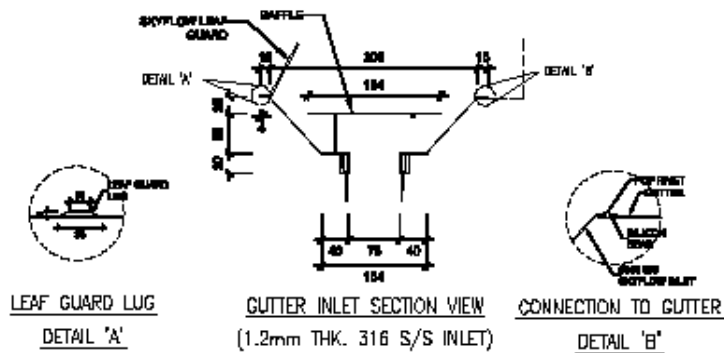



GUTTER INLET PLAN VIEW



These drawings are copyright & are not to be reproduced in any form without the express permission of Skyflow International Sdn. Bhd.

	Drawing Title	SKYFLOW 75 $\phi$ GUTTER INLET	Date	15.09.2016
	Scale	N.T.S.	Drawn By	E.H.
SKYFLOW International E-mail robert@skyflow.com.my Mobile +80 12307 3753	45, Jalan PJU 1A/15, Taman Perindustrian Jaya Ara Damansara, 46051 P. Jaya Selangor.		Checked By	R.A.
	Drawing No.	Rev.	SKY-INT003	0

### CONTACT INFO

-  +6 012-307 3753
-  08:30AM - 05:30PM
-  08:30AM - 05:30PM

### ADDRESS

No. 45 Jalan PJU 1A/15,  
Taman Perindustrian Jaya, Ara Damansara,  
46050 Selangor Darul Eshan, Malaysia

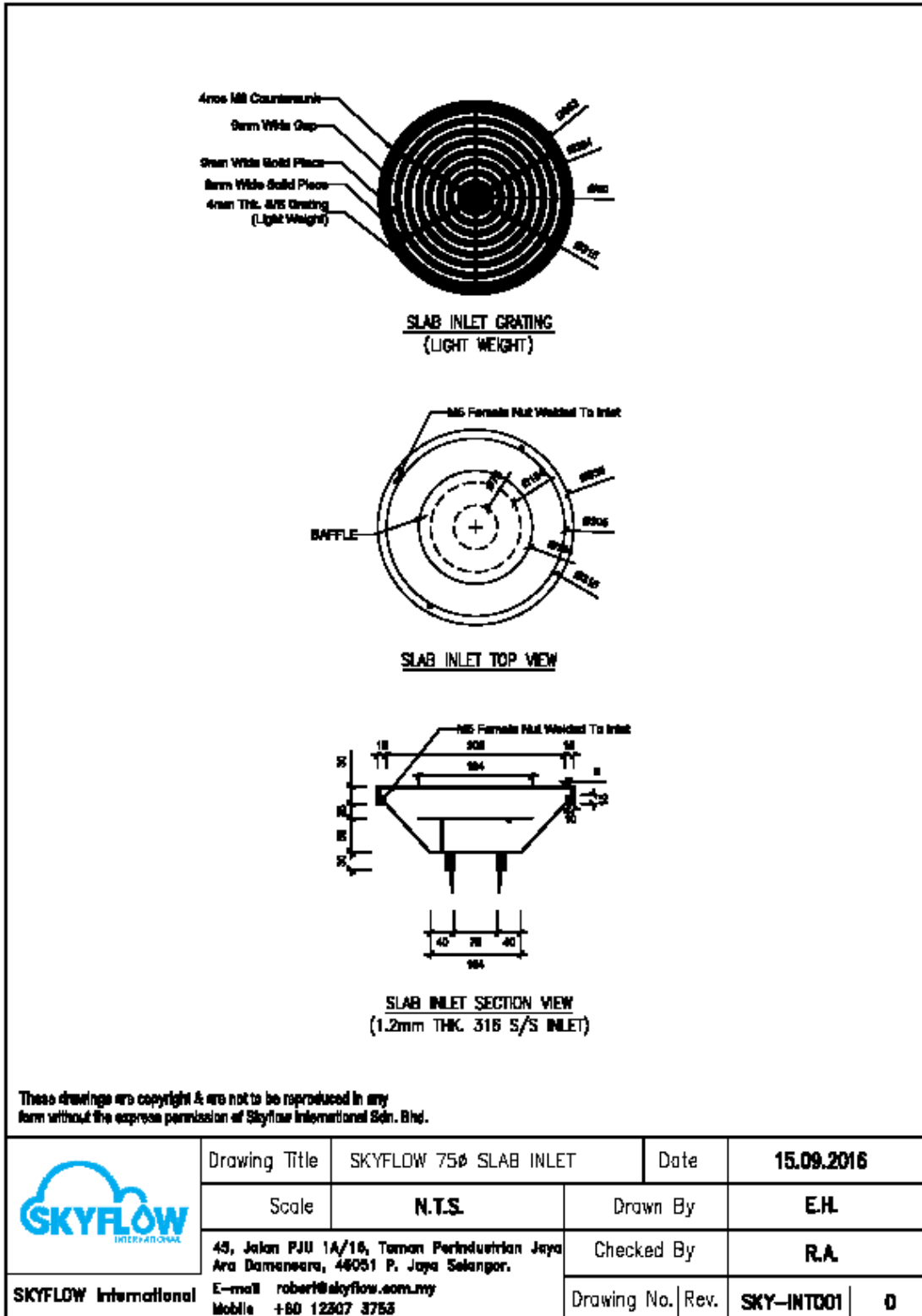

### CONTACT INFO

- +6 012-307 3753
- 08:30AM - 05:30PM
- 08:30AM - 05:30PM

### ADDRESS

No. 45 Jalan PJU 1A/15,  
 Taman Perindustrian Jaya, Ara Damansara,  
 46050 Selangor Darul Eshan, Malaysia

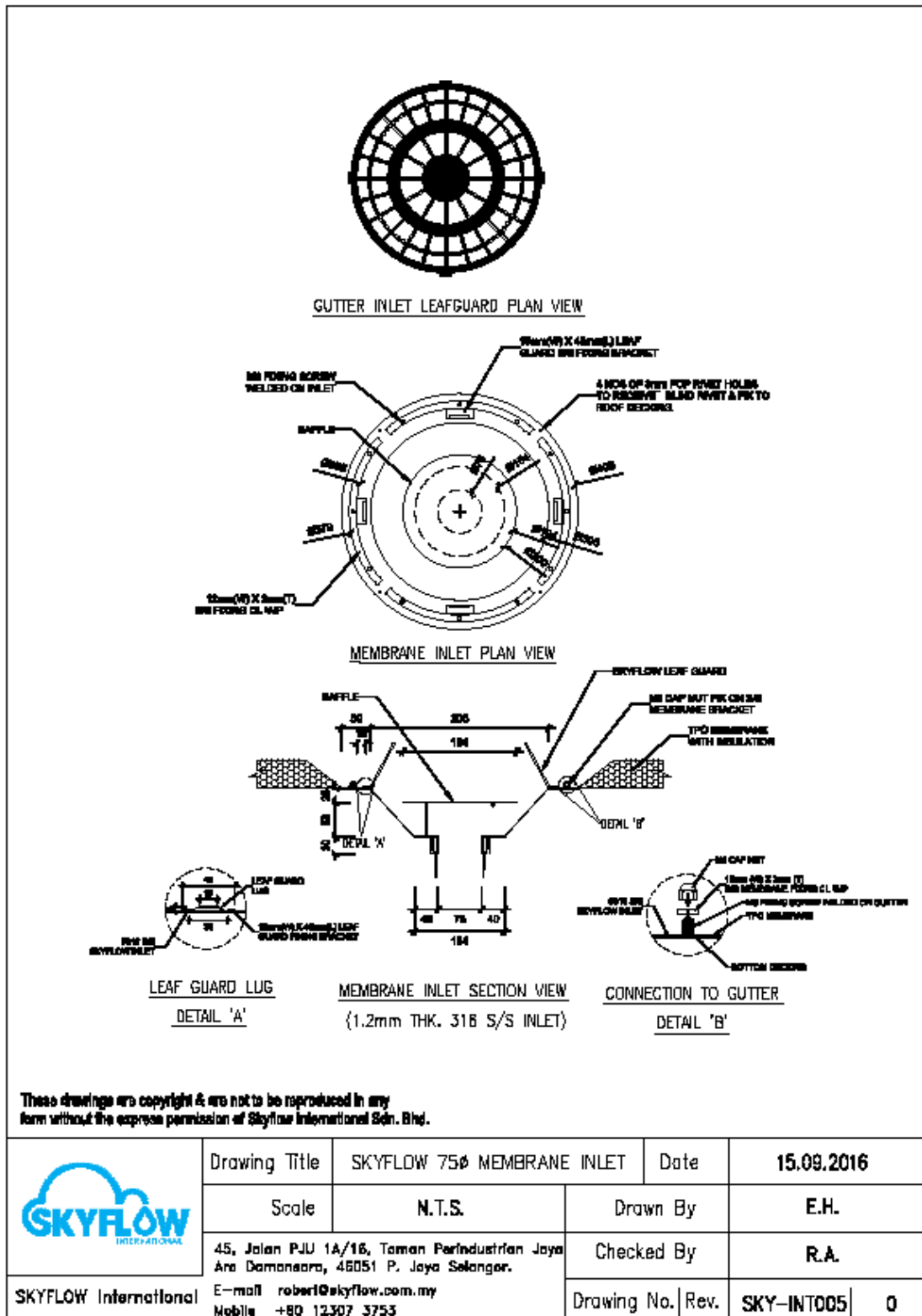

### CONTACT INFO

☎ +6 012-307 3753  
 ✉ 08:30AM - 05:30PM  
 🕒 08:30AM - 05:30PM

### ADDRESS

No. 45 Jalan PJU 1A/15,  
 Taman Perindustrian Jaya, Ara Damansara,  
 46050 Selangor Darul Eshan, Malaysia